

High Power

SEN-F CC 033

Fixture Guide

KKDÖ

Indoor/Outdoor | Recessed | Output up to 5490lm/m (1673lm/ft)



Key applications

- ✓ Architectural detail
- ✓ Building façades
- ✓ Floor
- ✓ Indirect lighting
- ✓ Interior/Exterior
- ✓ Orientation lighting
- ✓ Public spaces
- ✓ Uplighting
- ✓ Wall grazing

Key features

- ✓ Custom lengths
- ✓ Diffusion: Spotting
- ✓ Direct view
- ✓ In-ground walk/driveover
- ✓ IP67
- ✓ Lensed

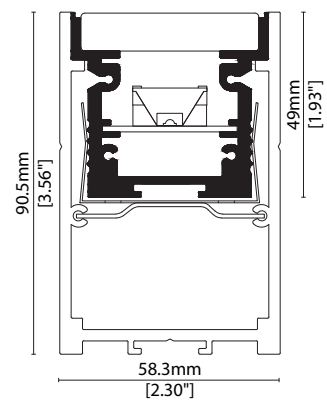

MOUNTING METHODS



KKSG-02 Ground box



SEN-F CC 033

Specification sheet



Dimensions	H48.9/W52.2/L210-1010mm (H1.93/W2.06/L8.27-39.76in)
PCB Cut-point	100mm (3.94in)
LED Pitch	33mm - 30LED/m (1.30in - 9.1LED/ft)
Chip	hcc-line: CREE/Lumileds
Cover/Optics	Clear + 10°/20°/30°/60°/Spread lens (10°x45°)/No lens
CCT	hcc-line White: 2700K/3000K/3500K/4000K/5000K hcc-line Single colours: Red/Green/Blue
LED binning	hcc-line: 3-step MacAdam Ellipse
CRI	80 (2700K-4000K)/75 (5000K)
Lifetime	50,000 hours @ 25°C (50,000 hours @ 77°F)
Operating temp	350mA: $T_a = -25^\circ\text{C}$ to 70°C ($T_c \text{ max} = 76^\circ\text{C}$) $T_a = -13$ to 158°F ($T_c \text{ max} = 168.8^\circ\text{F}$) 700mA: $T_a = -25^\circ\text{C}$ to 40°C ($T_c \text{ max} = 57^\circ\text{C}$) $T_a = -13$ to 104°F ($T_c \text{ max} = 134.6^\circ\text{F}$)
IP Rating	IP67
Finish	Silver anodised
Mounting	Ground Recessed Mounting
Power feed	Sheathed hardwire tail
Control	0-10V/1-10V/DMX/DALI via. External power supply options



LED Grading Key

Exclusive Grade

h- hcc-line*	*KKDC tuned CCT range
Constant Current Lensed	
High Power LED	
3-step CCT range	

Power consumption	Supply voltage	Supply current
TYP. 30W/m (9.14W/ft) @ 350mA	TYP. 86V/m (26.21V/ft) @ 350mA	0.35/0.7A/m (0.11/0.21A/ft)
TYP. 61W/m (18.59W/ft) @ 700mA	TYP. 87V/m (26.51V/ft) @ 700mA	

	Clear Cover 10°	Clear Cover 20°	Clear Cover 30°	Clear Cover 60°	Clear Glass Spread Lens	Clear Glass No Lens	Clear Glass + Micro Louvre	CRI	R9	Rf	Rg
hcc-line	3090lm/m (942lm/ft) 103lm/W @ 3000K, 350mA	3060lm/m (933lm/ft) 102lm/W @ 3000K, 350mA	2850lm/m (869lm/ft) 95lm/W @ 3000K, 350mA	3300lm/m (1006lm/ft) 110lm/W @ 3000K, 350mA	2970lm/m (905lm/ft) 99lm/W @ 3000K, 350mA	2460lm/m (750lm/ft) 82lm/W @ 3000K, 350mA	-60% Output when combined with Cover and Lens options	-	-	-	-
	5551lm/m (1692lm/ft) 91lm/W @ 3000K, 700mA	5490lm/m (1673lm/ft) 90lm/W @ 3000K, 700mA	5124lm/m (1562lm/ft) 84lm/W @ 3000K, 700mA	5917lm/m (1804lm/ft) 97lm/W @ 3000K, 700mA	5368lm/m (1636lm/ft) 88lm/W @ 3000K, 700mA	4392lm/m (1339lm/ft) 72lm/W @ 3000K, 700mA	-60% Output when combined with Cover and Lens options	-	-	-	-

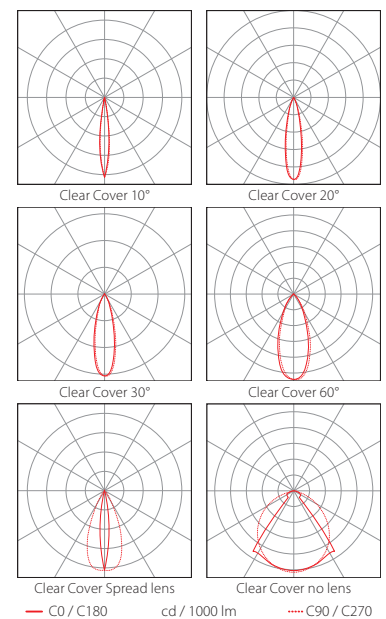
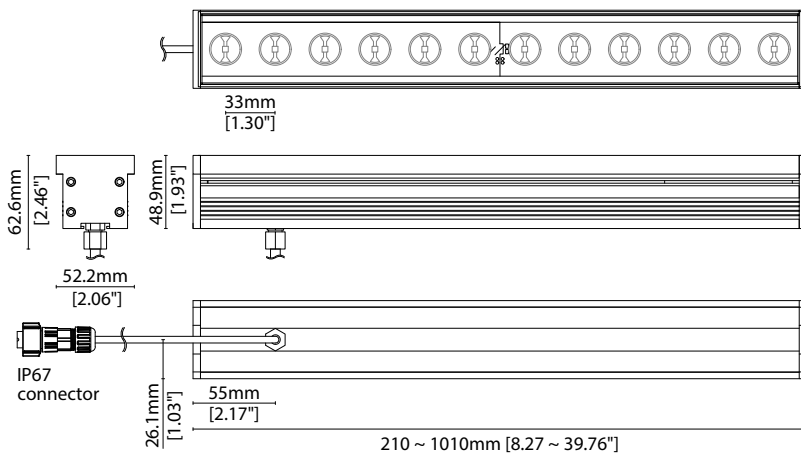

Data derived from independent UKAS/IESNA LM-79-08 accredited testing of production samples.



SEN-F CC 033

Code Table



FIXTURE

Model	Finish	Cover/Lens ¹	Grade ²	LED	Colour (CCT)	Length Availability ³	IP	Cable Length	Power Feed ⁴	Lens	Input																																														
SEN-F	SF	Silver Anodised	SA	Clear Glass	E	h ^{sc} h	033	2700K	27	m	210-1010mm 100mm increments	IP67	67	1000mm/ 39.37"	1000	Single ø6.3mm sheath tail	S00B	No lens	XX	Constant current (DC)	a																																				
																						Clear Glass+ Micro Louvre	L	3000K	30	i	8.27-39.76in 3.94in increments			Double ø6.3mm sheath tail	D00B	10°	10																								
																																		3500K	35			20°	20																		
																																								4000K	40			30°	30												
																																														5000K	50			60°	60						
																																																				RED	RED			Spread Lens	SL
BLUE	BLU																																																								

¹ Refer to **Cover/Lens Options** on **Options** pages

² Refer to **LED Grading Key** on **Specification sheet** page

³ Refer to **Length Availability List** or enter total run length instead of length code

⁴ Refer to **Power feed Options** on **Options** pages

Code Example:

SF	-	SA	-	L	-	h	-	033	-	30	-	m	-	610	-	67	-	1000	-	D00B	-	30	-	a
SEN-F		Silver Anodised		Clear Glass+Micro Louvre		h ^{sc}		033		3000K		610mm		IP67		1000mm/39.37"		Double ø6.3mm sheath tail		30°		Constant current (DC)		

ACCESSORIES

Mounting Accessories

KKSG-02 Ground box

* Refer to **Mounting accessories** on **Accessories** pages

Exterior Junction Boxes

KKJB-07 IP67 Slim J-Box

KKJB-07R Potting Resin for IP67 Slim J-Box

* Refer to **Exterior Junction Boxes** on **Accessories** pages

PSU/Driver

0-10V/1-10V/DALI/DMX via External power supply options

* Refer to **Driver/PSU Options** page for details or provide requirement and KKDC to offer the suitable option

LED ENGINE VARIANTS (LED STRIP TYPE)

Colour	LED	Lumen/m	Lumen/ft	W/m	W/ft	Spec Doc	Length	Increment
Single CCT	033	5917	1804	61	18.59	SEN-F CC 033	210-1010mm (8.27-39.76in)	100mm (3.94in)
	050	3977	1212	41	12.49	SEN-F CC 050	210-1010mm (8.27-39.76in)	100mm (3.94in)
	100	2058	627	21	6.40	SEN-F CC 100	210-1010mm (8.27-39.76in)	100mm (3.94in)

* Performance data: hcc-line, clear glass 60°, 700mA, 3000K

High Power

SEN-F CC 033 (350mA) Length Availability List



Length Code		Fixture Length ¹		LED Strip ²		End Cap Dimension ³		Wattage (W)	Output (lm)
Metric	Imperial(US)	Metric	Imperial(US)	Metric	Imperial(US)	Metric	Imperial(US)		3000K (Test Data)
m0210	i0008	210mm	8.27in	200mm	7.87in	10mm	0.39in	6.40	704
m0310	i0012	310mm	12.20in	300mm	11.81in	10mm	0.39in	9.60	1056
m0410	i0016	410mm	16.14in	400mm	15.75in	10mm	0.39in	12.80	1408
m0510	i0020	510mm	20.08in	500mm	19.69in	10mm	0.39in	16.00	1760
m0610	i0024	610mm	24.02in	600mm	23.62in	10mm	0.39in	19.20	2112
m0710	i0028	710mm	27.95in	700mm	27.56in	10mm	0.39in	22.40	2464
m0810	i0032	810mm	31.89in	800mm	31.50in	10mm	0.39in	25.60	2816
m0910	i0036	910mm	35.83in	900mm	35.43in	10mm	0.39in	28.80	3168
m1010	i0040	1010mm	39.76in	1000mm	39.37in	10mm	0.39in	32.00	3520

¹ Actual total overall length of light fixture (LED strip + end caps + void/wire hole)

² Actual length of PCB strip

³ Actual length of 2x end caps

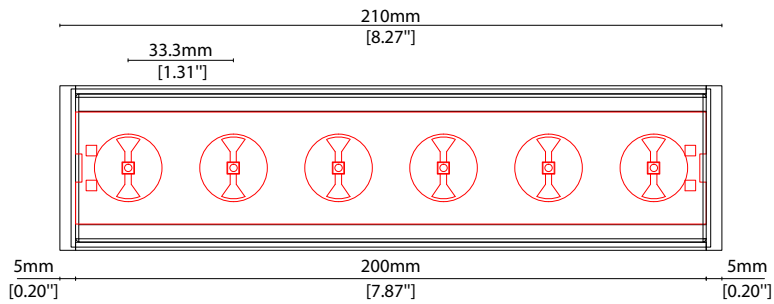

High Power

SEN-F CC 033 (700mA) Length Availability List



Length Code		Fixture Length ¹		LED Strip ²		End Cap Dimension ³		Wattage (W)	Output (lm)
Metric	Imperial(US)	Metric	Imperial(US)	Metric	Imperial(US)	Metric	Imperial(US)		3000K (Test Data)
m0210	i0008	210mm	8.27in	200mm	7.87in	10mm	0.39in	13.86	1261
m0310	i0012	310mm	12.20in	300mm	11.81in	10mm	0.39in	20.79	1892
m0410	i0016	410mm	16.14in	400mm	15.75in	10mm	0.39in	27.72	2523
m0510	i0020	510mm	20.08in	500mm	19.69in	10mm	0.39in	34.65	3153
m0610	i0024	610mm	24.02in	600mm	23.62in	10mm	0.39in	41.58	3784
m0710	i0028	710mm	27.95in	700mm	27.56in	10mm	0.39in	48.51	4414
m0810	i0032	810mm	31.89in	800mm	31.50in	10mm	0.39in	55.44	5045
m0910	i0036	910mm	35.83in	900mm	35.43in	10mm	0.39in	62.37	5676
m1010	i0040	1010mm	39.76in	1000mm	39.37in	10mm	0.39in	69.30	6306

¹ Actual total overall length of light fixture (LED strip + end caps + void/wire hole)

² Actual length of PCB strip

³ Actual length of 2x end caps

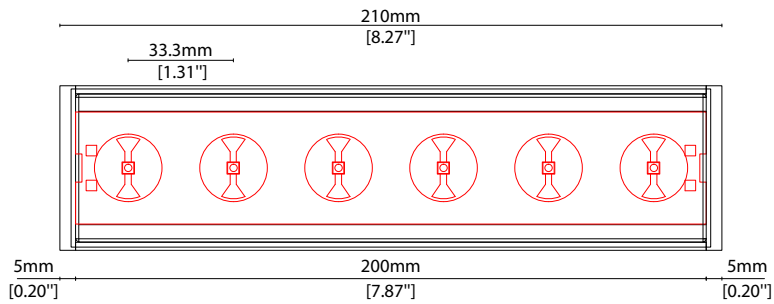

COVER OPTIONS

* Options are an integral part of the fixture ordering codes. Please refer to **Code Table** pages.

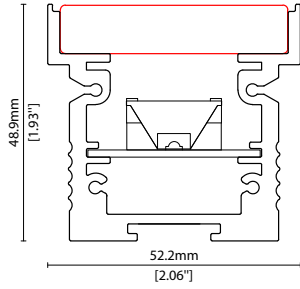

E 10 Clear glass 10° lens
W52.5/H48.9mm (W2.06/H1.93")

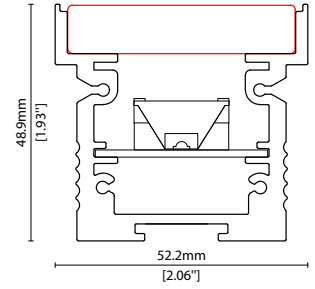

E 20 Clear glass 20° lens
W52.5/H48.9mm (W2.06/H1.93")

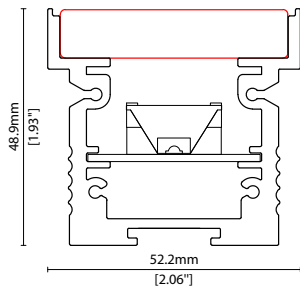

E 30 Clear glass 30° lens
W52.5/H48.9mm (W2.06/H1.93")

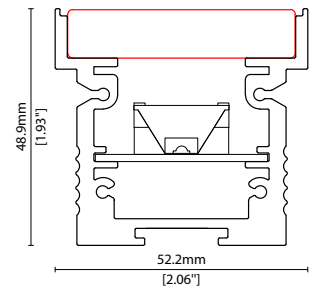

E 60 Clear glass 60° lens
W52.5/H48.9mm (W2.06/H1.93")

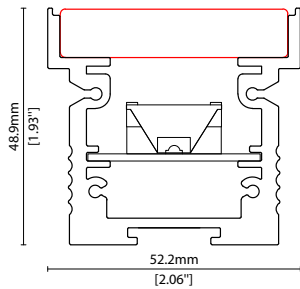

E SL Clear glass + Spread lens
W52.5/H48.9mm (W2.06/H1.93")

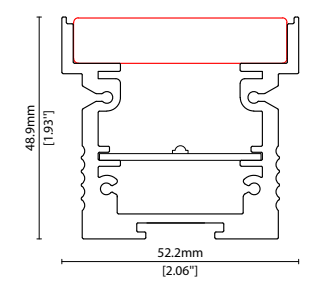

E XX Clear glass No lens
W52.5/H48.9mm (W2.06/H1.93")

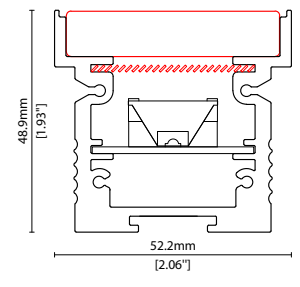

L Clear glass + Micro louvre
W52.5/H48.9mm (W2.06/H1.93")

POWER FEED OPTIONS

* Options are an integral part of the fixture ordering codes. Please refer to **Code Table** pages.

1000 S00B 1000mm (39.37") Single ø6.3mm sheath tail

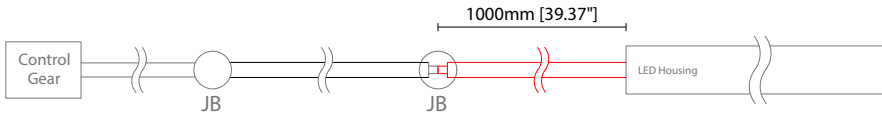

1000 D00B 1000mm (39.37") Double ø6.3mm sheath tail

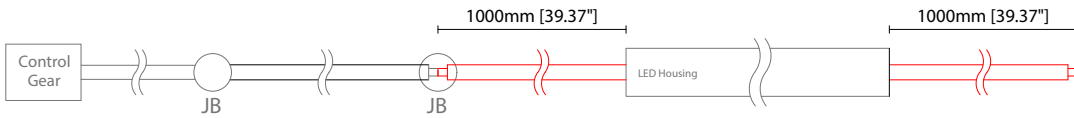

Key

Control Gear Power supply, sub-controllers & control systems
 JB Junction box / cable connection



SEN-F CC 033 Accessories



MOUNTING ACCESSORIES

Note: Accessories are to be ordered separately with corresponding code shown below.

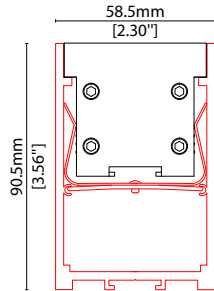

KKSG-02*

Ground box
Anodised aluminium finish

* Specify length to match SEN-F

EXTERIOR JUNCTION BOXES



KKJB-07

IP67 Slim J-Box
(including type A,B,C,D bushings)



KKJB-07R

Potting resin for IP67 Slim J-Box



SEN-F Driver/PSU Options



AVAILABLE PSU OPTIONS

Control Mode	PSU (Order Code)	Input Voltage AC	Output Voltage DC	Rated Output Current	Rated Power	Dim %	IP Rating
Switched	HLG-60H-C350A	90-305V	100V-200V	0.35A	70W	-	IP65
	HLG-60H-C700A	90-305V	50V-100V	0.7A	70W	-	IP65
	HLG-80H-C350A	90-305V	128V-257V	0.35A	90W	-	IP65
	HLG-80H-C700A	90-305V	64V-129V	0.7A	90W	-	IP65
	HLG-120H-C350A	90-305V	215-430V	0.35A	150W	-	IP65
	HLG-120H-C700A	90-305V	107V-215V	0.7A	150W	-	IP65
	HLG-185H-C700A	90-305V	143V-286V	0.7A	199W	-	IP65
0-10V (1-10V)	HLG-60H-C350B	90-305V	100V-200V	0.35A	70W	-	IP67
	HLG-60H-C700B	90-305V	50V-100V	0.7A	70W	-	IP67
	HLG-80H-C350B	90-305V	128V-257V	0.35A	90W	-	IP67
	HLG-80H-C700B	90-305V	64V-129V	0.7A	90W	-	IP67
	HLG-120H-C350B	90-305V	215-430V	0.35A	150W	-	IP67
	HLG-120H-C700B	90-305V	107V-215V	0.7A	150W	-	IP67
	HLG-185H-C700B	90-305V	143V-286V	0.7A	199W	-	IP67
DMX	POWERdrive 1060/A	120 - 277V	2V-57V	0.35A, 0.7A	100W	-	-
	POWERdrive 106/M	120 - 277V	2V-57V	0.35A, 0.7A	100W	-	-
	POWERdrive 106/S	120 - 277V	2V-57V	0.35A, 0.7A	100W	-	-
	POWERdrive 1061/M	120 - 277V	2V-57V	0.35A, 0.7A	100W	-	-
	POWERdrive 1061/S	120 - 277V	2V-57V	0.35A, 0.7A	100W	-	-
DALI	ELG-100-C350DA	180-295V	143-286V	0.35A	100W	-	IP67
	ELG-100-C700DA	180-295V	71-143V	0.7A	100W	-	IP67
	ELG-150-C700DA	180-295V	150-300V	0.7A	150W	-	IP67